

ORDINANCE NO. 4834  
File No. Z1020-0156

AN ORDINANCE OF THE CITY OF MESQUITE, TEXAS, AMENDING THE MESQUITE COMPREHENSIVE PLAN BY PROVIDING A COMPREHENSIVE PLAN AMENDMENT FROM COMMERCIAL TO LOW DENSITY RESIDENTIAL AND BY AMENDING THE MESQUITE ZONING ORDINANCE BY APPROVING A CHANGE OF ZONING ON PROPERTY GENERALLY LOCATED AT 430 PAZA DRIVE AND 1218 SOUTH BELT LINE ROAD FROM R-3 SINGLE-FAMILY RESIDENTIAL TO PLANNED DEVELOPMENT – SINGLE FAMILY RESIDENTIAL TO ALLOW A 99-LOT SINGLE-FAMILY SUBDIVISION SUBJECT TO CERTAIN STIPULATIONS; REPEALING ALL ORDINANCES IN CONFLICT WITH THE PROVISIONS OF THIS ORDINANCE; PROVIDING A SEVERABILITY CLAUSE; PROVIDING A PENALTY NOT TO EXCEED \$2,000.00; AND PROVIDING AN EFFECTIVE DATE.

WHEREAS, the Planning and Zoning Commission and the City Council, in compliance with the Charter of the City of Mesquite, state laws and the zoning ordinance, have given the required notices and held the required public hearings regarding the rezoning of the subject property; and

WHEREAS, the City Council finds that it is in the public interest to grant this change in zoning.

NOW, THEREFORE, BE IT ORDAINED BY THE CITY COUNCIL OF THE CITY OF MESQUITE, TEXAS:

SECTION 1. The subject property is described as being approximately 22.08 acres currently zoned R-3 Single-Family Residential, generally located at 430 Paza Drive and 1218 South Belt Line Road, and is more fully described in the legal descriptions attached hereto as Exhibits A-1 and A-2 (collectively the “**Property**”).

SECTION 2. The Mesquite Comprehensive Plan, last updated on October 7, 2019, and the zoning map of the City, be and the same are hereby amended by changing the future land use for the Property from Commercial to Low Density Residential.

SECTION 3. The Mesquite Zoning Ordinance is hereby amended by approving a change of zoning for the Property from R-3 Single-Family Residential to Planned Development – Single-Family Residential with underlying zoning of R-3 to allow a 99-lot single-family subdivision with the following stipulation:

1. Development of the site shall conform generally to the Planned Development Standards, the Concept Plan and the ROW Section with Typical Utilities, attached hereto as Exhibits B, C and D, respectively, and made a part thereof, as determined by the Director of Planning and Development Services.

SECTION 4. All ordinances, or portions thereof, of the City of Mesquite in conflict with the provisions of this ordinance, to the extent of such conflict are hereby repealed; otherwise, they shall remain in full force and effect.

SECTION 5. The Property shall be used only in the manner and for the purposes provided for by the Mesquite Zoning Ordinance, as amended.

SECTION 6. Should any word, sentence, clause, paragraph or provision of this ordinance be held to be invalid or unconstitutional, the remaining provisions of this ordinance shall remain in full force and effect.

SECTION 7. Any person (as defined in Chapter 1, Section 1-2 of the Code of the City of Mesquite, Texas, as amended) violating any of the provisions or terms of this ordinance shall be deemed to be guilty of a Class C Misdemeanor and upon conviction thereof, shall be subject to a fine not to exceed \$2,000.00 for each offense, provided, however, if the maximum penalty provided for by this ordinance for an offense is greater than the maximum penalty provided for the same offense under the laws of the State of Texas, the maximum penalty for violation of this ordinance for such offense shall be the maximum penalty provided by the laws of the State of Texas. Each day or portion of a day any violation of this ordinance continues shall constitute a separate offense.

SECTION 8. This ordinance shall take effect and be in force from and after five days after publication.

DULY PASSED AND APPROVED by the City Council of the City of Mesquite, Texas, on the 7th day of December 2020.

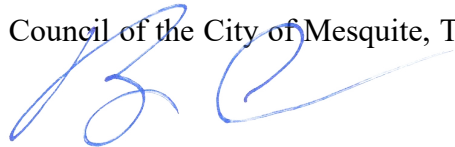

---

Bruce Archer  
Mayor

ATTEST:

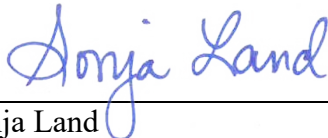

---

Sonja Land  
City Secretary

APPROVED AS TO LEGAL FORM:



---

David L. Paschall  
City Attorney

EXHIBIT A-1  
Legal Description for  
430 Paza Drive

Being a tract of land situated in the William J. Lewis Survey, Abstract No. 814 and in the John Scurlock Survey, Abstract No. 1368, City of Mesquite, Dallas County, Texas, being a portion of the Second Installment, Open Doors Baptist Church Addition, an addition the City of Mesquite, Dallas County, Texas as shown thereof and recorded in Volume 81025, Page 220, Official Public Records Dallas County, Texas, (OPRDCT), and being a portion of a certain called tract of land as described by deed to Open Door Baptist Church and recorded in Volume 80242, Page 1213, (OPRDCT) and being more particularly described by metes and bounds as follows ( Basis of bearings reference to the Texas State Plane Coordinate System, North Central Zone, NAD83 via the Trimble VRS network for North Central Texas. All distances are surface distances.)

BEGINNING at a ½-inch capped iron rod found marked By-Line for the southwest corner of the said Second Installment and being common with the north line of the said Open Door Church tract, also being common with the southeast corner of certain called 4.066 acre Lot, Open Doors Baptist Church Addition, an addition to the City of Mesquite, Dallas County, Texas, as shown thereof and recorded in Volume 72173, Page 795, (OPRDCT);

THENCE North 00°25'39" West, with the west line of the said Second Installment, being common with the east line of the said 4.066 acre Lot and being common with the east line of Lot 1, Block 1, First Presbyterian Church Addition, an addition to the City of Mesquite, Dallas County, Texas, as shown thereof and recorded in Volume 90199, Page 793, (OPRDCT), a distance of 1076.47 feet to a bent ½-inch iron rod found for the northwest corner of the said Second Installment and being in the south right of way line of Paza Drive ( a variable width right of way);

THENCE South 85°38'57" East, with the westerly north line of the said Second Installment and being with the south right of way line of the said Paza Drive, a distance of 232.21 feet to a ½-inch iron rod found for the northwest corner of a certain called tract of land as described by deed to 434 Paz Land LLC, a Texas Limited Liability Company, and recorded in County Clerk's No. (CC#) 201200181379, (OPRDCT)

THENCE southerly and easterly with the said 434 Paz tract, the following courses and distances:

South 00°06'59" East, a distance of 451.95 feet to a ½-inch iron rod found;  
North 89°57'45" East, a distance of 350.48 feet to a 5/8-inch capped iron rod marked Shield Engineering set for the southeast corner of the said 434 Paz tract and being in the east line of the aforesaid Second Installment, also being in the east right of way line of Wilkinson Drive ( a variable width right of way), from which a 2-inch iron pipe found bears North 47°21'10" West, a distance of 1.08 feet;

THENCE southerly with the east line of the aforementioned Second Installment, being with the west right of way line of said Wilkinson Drive, being common with the west line of Block J and Block H, Casa Terrace No. 4, an addition to the City of Mesquite, Dallas County, Texas, as shown thereof and recorded in Volume 85062, Page 4914, (OPRDCT), and over and across the said Open Door Church Tract, the following course and distance:

South 00°26'59" East, a distance of 926.46 feet to a 5/8-inch capped iron rod marked Shield Engineering set for the PC of a curve to the left having a radius of 716.20 feet;

With said curve to the left, having a central angle of 11°51'26", a chord bearing and distance of South 06°22'44" East, a distance of 147.95 feet, an arc distance of 148.22 feet to a 5/8-inch capped iron rod marked Shield Engineering set for the southwest corner of Lot 11, of said Block H and being in the north line of a 18 foot alley, Spring Creek Addition, an addition to the City of Mesquite, Dallas County, Texas, as shown on plat thereof and recorded in Volume 73131, Page 1841, (OPRDCT);

THENCE South 89°07'01" West, with the north line of said alley, a distance of 774.94 feet to a 5/8-inch capped iron rod marked Shield Engineering set for the northwest corner of said alley and being in the east line of a certain called tract of land as described by deed to Michael Dwain Bradshaw and Jerri Baffett Bradshaw and recorded in Volume 95136, Page 3020, (OPRDCT), from which a 3/8-inch iron rod found bears South 83°12'09" East, a distance of 4.02 feet;

THENCE with the said Bradshaw tract, the following courses and distances:

North 03°05'03" West, a distance of 179.95 feet to a ½" iron rod found;

South 87°15'56" West, at 323.75 feet pass a 5/8-inch capped iron rod marked Shield Engineering set for reference and continuing a total distance of 343.75 feet to a point in the center line of creek;

THENCE northerly with said creek the following courses and distances:

North 21°25'40" East, a distance of 48.34 feet to a point;  
South 71°38'57" East, a distance of 52.39 feet to a point;  
North 32°56'22" East, a distance of 48.42 feet to a point;  
North 08°28'36" West, a distance of 34.16 feet to a point;  
North 34°27'40" West, a distance of 47.95 feet to a point;  
North 85°22'59" West, a distance of 34.72 feet to a point;  
North 37°33" 57" West, a distance of 17.27 feet to a point;  
North 07°55'08" East, a distance of 44.18 feet to a point;  
North 00°03'20" East, a distance of 28.89 feet to a point;  
North 57°39'40" East, a distance of 26.46 feet to a point;  
South 80°30'52" East, a distance of 9.78 feet to a point;  
South 03°21'49" West, a distance of 19.57 feet to a point;  
North 74°37'30" East, a distance of 12.03 feet to a point;  
North 45°37'30" East, a distance of 32.28 feet to a point;  
North 55°22'14" East, a distance of 40.56 feet to a point;  
North 37°58'27" East, a distance of 26.72 feet to a point;  
South 87°06'42" East, a distance of 48.36 feet to a point;  
South 77°25'28" East, a distance of 41.47 feet to a point;  
North 30°48'08" East, a distance of 32.25 feet to a point in the north line of

the aforesaid Open Door Church tract and being in the south line of the said 4.066 acre Lot, from which a 5/8-inch capped iron rod marked Shield Engineering set for reference bears South 89°08'27" East, a distance of 20.00 feet;

THENCE North 89°08'27" East, with the south line of the aforesaid 4.066 acre tract and being common with the north line of the aforementioned Open Door Church tract a distance of 286.12 feet to the POINT OF BEGINNING, containing 902,433 square feet or 20.717 acres of land more or less.

EXHIBIT A-2  
Legal Description for  
1218 South Belt Line Road

Being a tract of land situated in the John Scurlock Survey, Abstract No. 1368, City of Mesquite, Dallas County, Texas, being a portion of a certain called tract of land as described by deed to Open Door Baptist Church and recorded in Volume 80242, Page 1213, (OPRDCT) and being more particularly described by metes and bounds as follows ( Basis of bearings reference to the Texas State Plane Coordinate System, North Central Zone, NAD83 via the Trimble VRS network for North Central Texas. All distances are surface distances.)

BEGINNING at a ½-iron rod found in the north line of the said Open Door Church tract, and being in the south line of the 4.066 acre Lot, Open Doors Baptist Church Addition, an addition to the City of Mesquite, Dallas County, Texas, as shown on plat thereof and recorded in Volume 72173, Page 795, (OPRDCT), also in the east right of way line of South Beltline Road ( a variable width right of way);

THENCE North 89°08'27" East, with the north line of the said Open Door Church tract, and being common with the south line of the 4.066 acre Lot, at 349.53 pass a 5/8-inch capped iron rod marked Shield Engineering set for reference and continuing a total distance of 369.53 feet to a point in the centerline of creek, from which a ½-inch capped iron rod marked By-Line found for the southeast corner of the said 4.066 acre Lot bears North 89°08'27" East, a distance of 286.12 feet;

THENCE southerly with the said creek the following courses and distances:

South 30°48'08" West, a distance of 32.25 feet to a point;  
North 77°25'28" West, a distance of 41.47 feet to a point;  
North 87°06'42" West, a distance of 48.36 feet to a point;  
South 37°58'27" West, a distance of 26.72 feet to a point;  
South 55°22'14" West, a distance of 40.56 feet to a point;  
South 45°37'30" West, a distance of 32.28 feet to a point;  
South 74°37'30" West, a distance of 12.03 feet to a point;  
North 03°21'49" East, a distance of 19.57 feet to a point;  
North 80°30'52" West, a distance of 9.78 feet to a point;  
South 57°39'40" West, a distance of 26.46 feet to a point;  
South 00°03'20" West, a distance of 28.89 feet to a point;  
South 07°55'08" West, a distance of 44.18 feet to a point;  
South 37°33" 57" East, a distance of 17.27 feet to a point;  
South 85°22'59" East, a distance of 34.72 feet to a point;  
South 34°27'40" East, a distance of 47.95 feet to a point;

South 08°28'36" East, a distance of 34.16 feet to a point;  
South 32°56'22" West, a distance of 48.42 feet to a point;  
North 71°38'57" West, a distance of 52.39 feet to a point;  
South 21°25'40" West, a distance of 48.34 feet to a point in the south line of the said Open Door Church tract and being in the north line of a certain called tract of land as described by deed to Michael Dwain Bradshaw and Jerri Baffett Bradshaw and recorded in Volume 95136, Page 3020, (OPRDCT), from which a 5/8-inch capped iron rod marked Shield Engineering set for reference bears North 87°15'56" West, a distance of 20.00 feet;

THENCE South 87°15'56" West, with the south line of the said Open Doors Church tract, and being common with the north line of the Bradshaw tract, a distance of 120.68 feet to a 5/8-inch capped iron rod marked Shield Engineering set in the east right of way line of said Beltline Road, from which a ½-inch iron rod found for the northwest corner of the said Bradshaw tract bears South 87°15'56" West, a distance of 5.16 feet;

THENCE North 01°03'44" West, with the east right of way line of the said South Beltline Road, a distance of 311.00 feet to the POINT OF BEGINNING, containing 59,302 square feet or 1.361 acres of land more or less.

## EXHIBIT B

### PLANNED DEVELOPMENT STANDARDS

The Property shall be developed as single-family detached lots in accordance with the land uses and development standards for the (R-3) Single-Family District base zoning district with the following exceptions, special conditions, restrictions and regulations:

#### General:

1. Development shall be in general conformance with the following exhibits:
  - a. Conceptual Layout as shown on Exhibit C –Zoning Concept Plan; and
  - b. Typical Residential Paving Section shown on Exhibit D.
2. A homeowner’s association (HOA) shall be established prior to recording the final plat for the Property.
3. The HOA will be responsible for the improvement and maintenance of all common areas and/or common facilities dedicated to the HOA.
4. Traffic calming devices shall be installed as required by the Manager of Traffic Engineering in certain critical areas. Speed bumps are prohibited.

#### Streets and Utilities Improvements:

1. Streets shall be designed with a 50-foot wide street right-of-way, a 31-foot “back-to-back” pavement cross section with a 5” crown, and a 5-foot utility easement on either side of the street right-of-way for franchise utilities in accordance with Exhibit D. Mountable curbs shall be allowed.
2. Alleys are not required.
3. Water and Sanitary Sewer mains shall be located in the parkway between the back of curb and right-of-way line. Storm sewer mains shall be located in the center of the pavement.

#### Lots and Homes:

1. Minimum lot area: 4,400 square feet.
2. Minimum floor area of homes: 1,500 square feet.
3. Maximum building coverage, excluding lead walks, driveways, patios, and other flatwork: 60%
4. Minimum lot width (measured along the front building line):
  - a. 40 feet, except; and
  - b. For all lots on cul-de-sacs and around "eyebrows" the minimum frontage of the lot shall be 30 feet measured along the right-of-way.
5. Minimum lot depth:
  - a. 110 feet, except lots on cul-de-sacs and around "eyebrows" shall have a minimum lot depth of 90 feet.
6. Minimum Setbacks:
  - a. Minimum front yard setback shall be 20 feet.
  - b. Garage does not have to be recessed behind main structure.
  - c. Minimum interior side yard setback shall be 5 feet.
  - d. Minimum street side yard setback shall be 10 feet on standard lots and 20 feet on key lots.



## EXHIBIT B

### PLANNED DEVELOPMENT STANDARDS

- e. Minimum rear yard setback shall be 15 feet. However, a rear covered patio may encroach into the rear yard setback by up to 5 feet.
  - f. On corner lots, the “corner clips” shall not be considered when measuring setbacks. In no case shall buildings, structures, or fencing impact site visibility.
7. Carports are prohibited.
  8. Front-entry garages are permitted.
  9. Driveways on corner lots shall be located a minimum of 30 feet from the back of curb on the adjacent side street to the edge of the driveway at the fronting right-of-way.
  10. At the time of home construction, home builders shall plant a minimum of one 3” caliper street tree in the front yard for every lot.

#### Amenities:

1. Open Space/Parkland:  
Open Space or Parkland shall be provided in general conformance with Exhibit C – Zoning Concept Plan, shall include the following and shall satisfy all open space requirements:
  - a. A playground, gazebo, and grassed open space on the north end of the Property;
  - b. Open Space/Parkland will be provided along the northern boundary adjacent to Paza Drive;
  - c. Open Space shall be provided for sidewalk/trail linkage from the open space near the northern boundary and along the western boundary of the Property; and
  - d. No Parkland dedication or fees-in-lieu-of land shall be required for the project in consideration of the Open Space/Parkland provided.
2. Landscaping  
The landscape buffer along Wilkinson Drive shall include the following:
  - a. A minimum two shade trees for each 100 feet or fraction thereof, five ornamental trees for each 100 linear feet or fraction thereof, and 65 shrubs or ornamental grasses for each 100 linear feet or fraction thereof.
3. Sidewalks/Trails:
  - a. Developer shall construct the following sidewalks/trails:
    - (i.) 6’ sidewalk/trail generally meandering through the Open Space near Paza Drive;
    - (ii.) 6’ sidewalk/trail generally meandering through the Open Space and along the frontage of lots along the western side of the Property within the right of way of the western-most streets;
    - (iii.) 6’ sidewalk/trail generally meandering adjacent to the northern boundary of the western-most tier of lots, connecting the 6’ sidewalk/trail described in (ii.) above; and
    - (iv.) 5’ sidewalks within right-of-way adjacent to any open space that does not include a sidewalk/trail noted in previous items above.
  - b. Homebuilders shall construct 5’ sidewalks along the entire frontage of each individual lot within the right-of-way (including side of the lot for corner lots) at the time the home is constructed. Sidewalks shall be constructed in the public right-of-way.
  - c. Sidewalks/Trails shall be constructed of concrete or other material approved by the City.

## EXHIBIT B

### PLANNED DEVELOPMENT STANDARDS

4. Walls and Fencing:
  - a. A 6' board on board fence with masonry columns (brick or stone) shall be constructed along the northern boundary of the Property and a minimum 50" wrought iron fence with landscaping along the eastern boundary of the Property shall be provided along the boundary shared with the adjacent nursing center.
  - b. A 6' board on board fence with masonry columns (brick or stone) shall be constructed along the eastern boundary of the Property adjacent to Wilkinson Drive.
  - c. With a minimum of 6-feet in height, a wood fence shall be provided along the southern and eastern property boundaries adjacent to existing alleys.
  - d. At the time of home construction, Homebuilders shall construct a minimum 50" wrought iron fence on lots that are adjacent to the creek on the western boundary.
  - e. No additional perimeter walls or fencing will be required.

**LEGEND**

- FEMA ZONE AE - 100-YR FLOODPLAIN
- PARK DEDICATION / OPEN SPACE
- LAND TO BE CONVEYED TO NEIGHBOR

TOTAL = 99 RESIDENTIAL LOTS

**PLANNED DEVELOPMENT DATA**

TOTAL ACRES = 20.72 ACRES  
 OPEN SPACE = 5.51 ACRES  
 DENSITY = 4.78 LOTS PER ACRE

- TYPICAL LOT SIZE: 40' X 115'
  - ADJACENT TO STREET: ADD 10' WIDTH
  - MINIMUM LOT WIDTH: 40'
  - MINIMUM LOT DEPTH: 110'
  - MINIMUM DEPTH OF LOTS ON CURVES, CUL-DE-SACS, AND EYEBROWS: 90'
- SETBACKS:
- FRONT: 20'
  - TYPICAL SIDE YARD: 5'
  - REAR: 15'
  - PATIO ENCROACHMENT INTO REAR YARD SETBACK: 5'
  - SIDE YARD SETBACK ADJACENT TO A STREET: 10'

LINE #	BEARING	LENGTH
L1	S30°48'08"W	32.25'
L2	N77°25'28"W	41.47'
L3	N87°06'42"W	48.38'
L4	S37°58'27"W	26.72'
L5	S55°22'14"W	40.56'
L6	S45°37'30"W	32.28'
L7	S74°37'30"W	12.03'
L8	N03°21'49"E	19.57'
L9	N80°30'52"W	9.78'
L10	S57°39'40"W	26.46'
L11	S00°03'20"W	28.89'
L12	S07°55'08"W	44.18'
L13	S37°33'57"E	17.27'
L14	S85°22'59"E	34.72'
L15	S34°27'40"E	47.95'
L16	S08°28'36"E	34.16'
L17	S32°56'22"W	48.42'
L18	N71°38'57"W	52.39'
L19	S21°25'40"W	48.34'

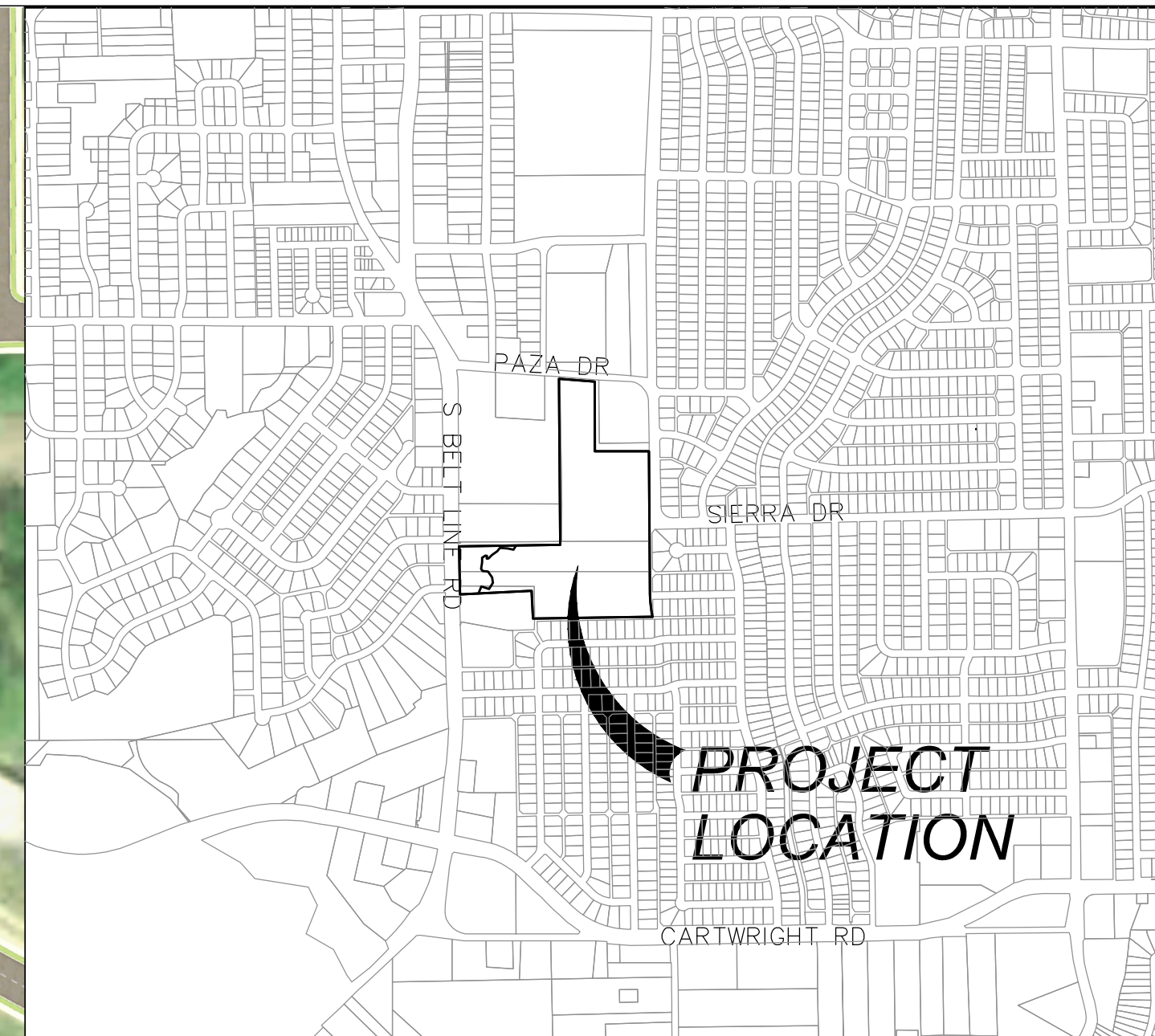
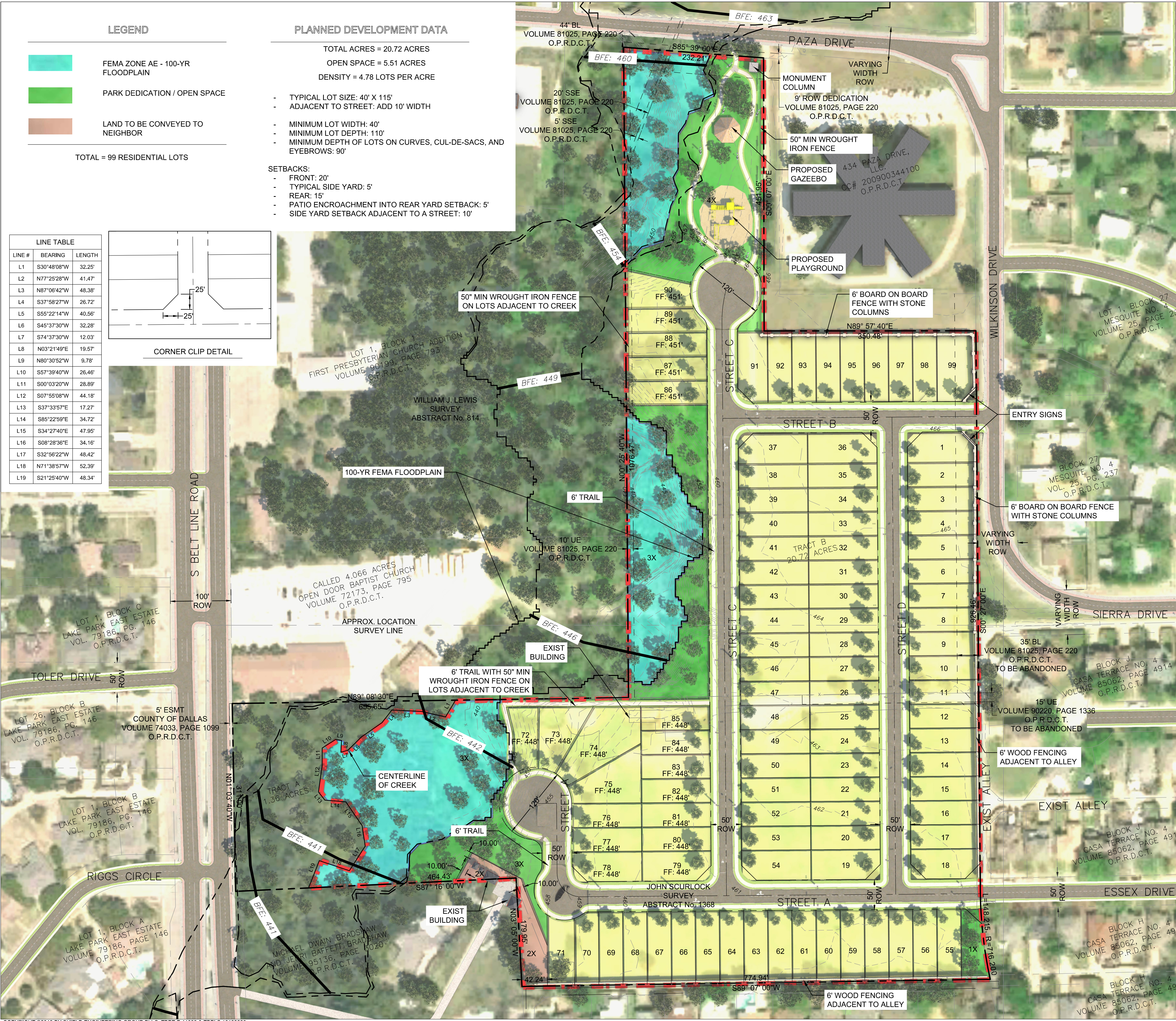
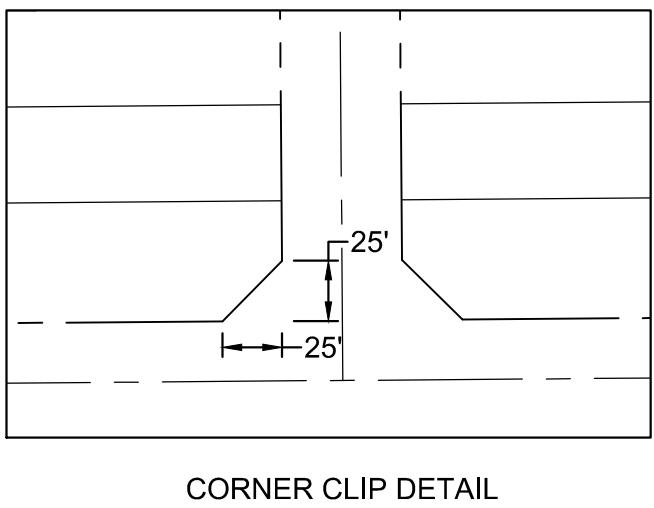

**VICINITY MAP  
NTS**

- NOTES:
- EXISTING ZONING: R3
  - DEVIATIONS FROM CURRENT DEVELOPMENT STANDARDS/REGULATIONS NOT SPECIFICALLY ADDRESSED/LISTED FOR APPROVAL AS PART OF PLANNED DEVELOPMENT REGULATIONS MAY REQUIRE A HEARING/APPROVAL BY THE BOARD OF ADJUSTMENT (BOA).
  - ALL CURRENT DEVELOPMENT REQUIREMENTS OF THE CITY AS AMENDED SHALL BE MET UNLESS APPROVED OTHERWISE WITHIN THESE PLANNED DEVELOPMENT ZONING DISTRICT DEVELOPMENT REGULATIONS.
  - THIS ZONING CONCEPT PLAN IS FOR ILLUSTRATIVE PURPOSES ONLY AND SUBJECT TO CHANGE. THIS ZONING CONCEPT PLAN, ALONG WITH DEVELOPMENT REGULATIONS, IS INTENDED TO DESCRIBE THE INTENT OF THE PLANNED DEVELOPMENT. SIGNIFICANT DEVIATIONS FROM THIS ZONING CONCEPT PLAN, AS DETERMINED BY THE DIRECTOR OF PLANNING AND DEVELOPMENT SERVICE, WILL REQUIRE AN AMENDMENT TO THE ZONING CONCEPT PLAN AND, AS NECESSARY, THE DEVELOPMENT REGULATIONS.

<p>OWNER M/I HOMES OF DFW, LLC 405 STATE HWY 121, SUITE A-210 LEWISVILLE, TX 76034</p>	<p>ENGINEER/SURVEYOR SHIELD ENGINEERING GROUP, PLLC 1600 WEST 7TH STREET, SUITE 200 FORT WORTH, TX 76102 817-810-0696</p>
--	---

SHIELD

ENGINEERING GROUP

TBPE FIRM #F-11039 & TBPLS FIRM #10193890

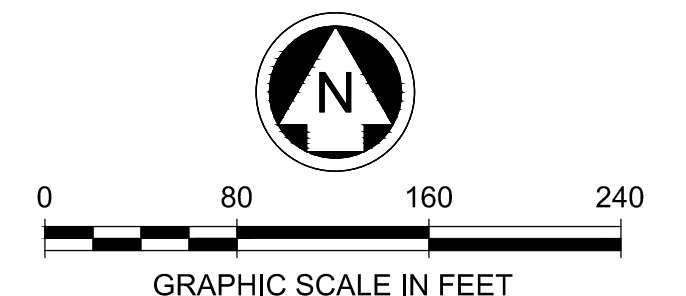

MESQUITE, TEXAS

ESPERANZA

EXHIBIT X - ZONING CONCEPT PLAN

DESIGNED: JCK	SCALE: 1" = 80'	DATE: 10/16/2020	SHEET: 1 OF 1
---------------	-----------------	------------------	---------------

2020/10/16 LIBARRA, L. LOBOS/2020/08/01 ESPERANZA, S.F. EXHIBIT C ZONING CONCEPT PLAN ZONING CONCEPT PLAN.DWG

ESPERANZA SF

2020/10/26 AJUAN LUDBS202006.01 ESPERANZA SF/CUT/2020/10/26 AUTOTURN EXHIBIT TO CLIENT/2020/10/26 AUTOTURN EXHIBIT.DWG

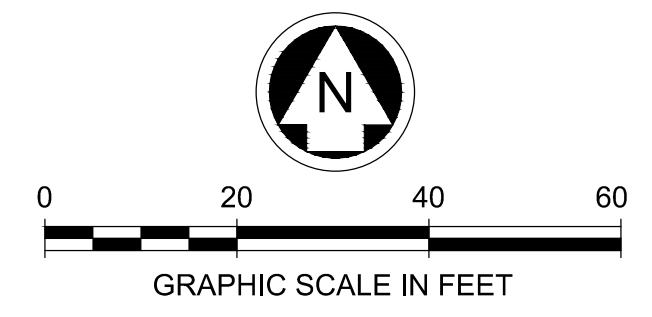
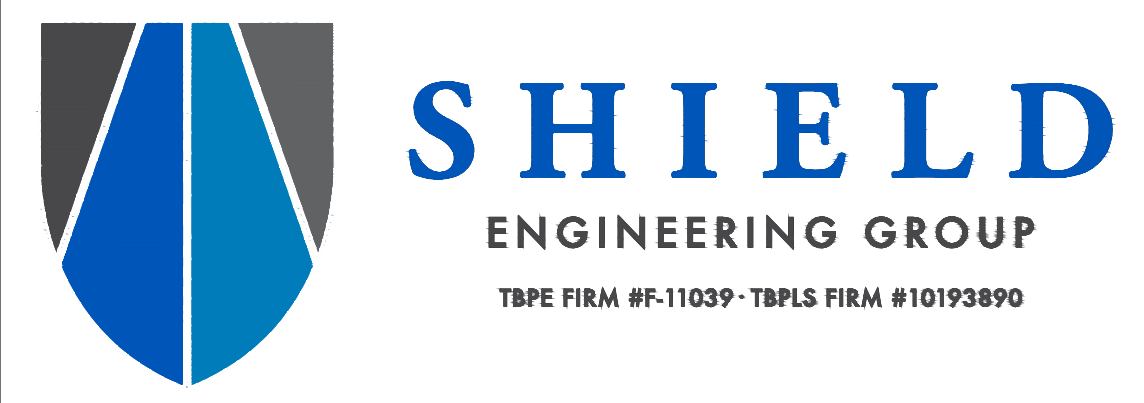
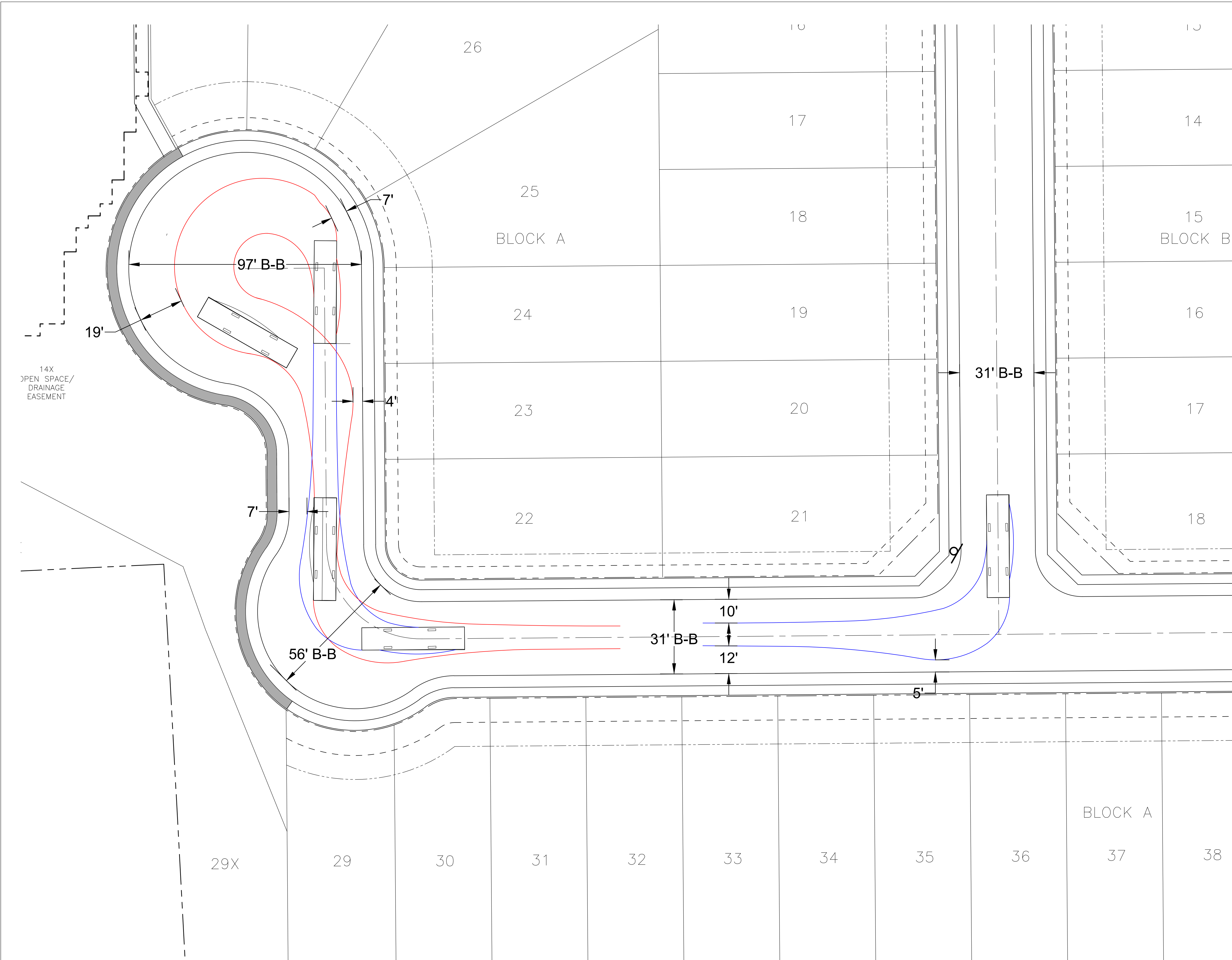

FORT WORTH, TEXAS

ESPERANZA SF

AUTOTURN EXHIBIT

DESIGNED: _____	SCALE: N.T.S.	DATE: April 2020	x OF
DRAWN: _____			

**TYPICAL RESIDENTIAL PAVING SECTION**

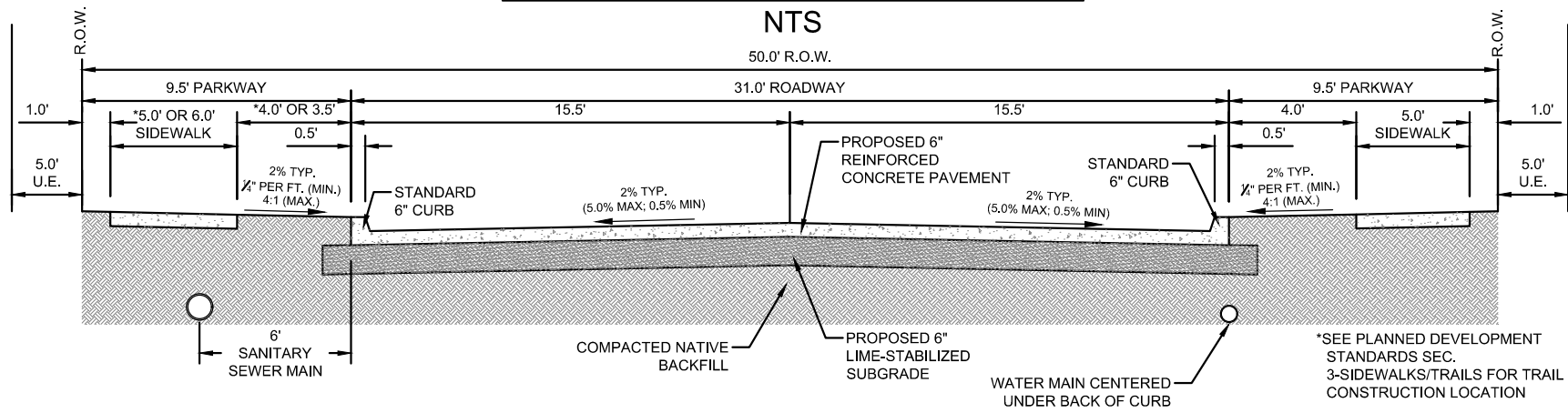



**SHIELD**  
ENGINEERING GROUP

---

Z1020-0156,  
1212 S. Belt Line Rd.  
ESPERANZA SF

---

**EXHIBIT D**  
ROW SECTION WITH  
TYPICAL UTILITIES